

Push Terminals
For quick installation

The AVE-UTP-X1500 Passive Hubs

AVE UTP Passive Transmitters and Receivers bring the ease of using structured Unshielded Twisted Pair Cable such as CAT3,4,5,6 for transmission of video signals. For multiple camera installations the use of the AVE Passive Hubs simplify installation even further. The AVE hubs are available in 4, 8 and 16 Channel Push Cage Clamps for individual UTP connections or a common RJ45 for CAT5 which can accommodate 4 video cameras in one cable run can be used. The fully compatible product line allows the interchangeability of components in the AVE UTP range.

UTP PASSIVE HUBS

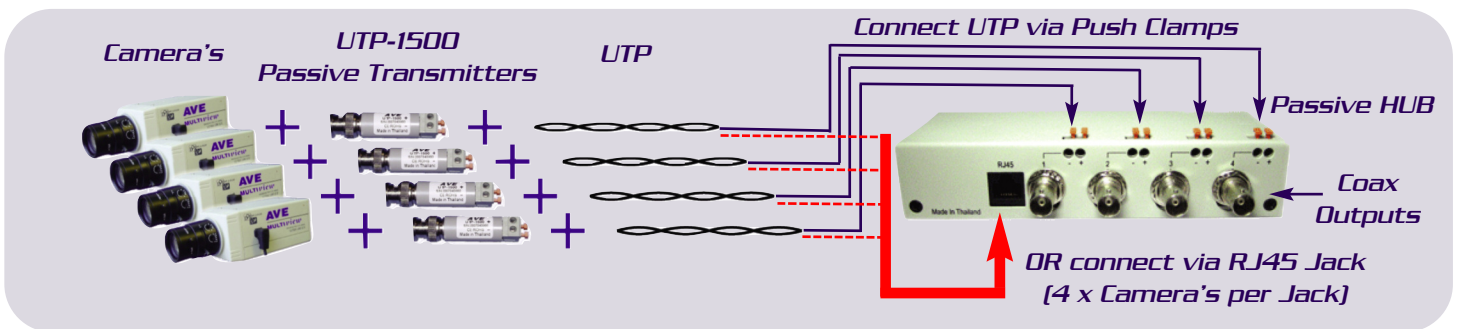

4 Channel Passive Hub - AVE-UTP-4x1500

AVE-UTP-4X1500 With push cage clamps & structured Wiring RJ45 for use with Passive UTP Transmitters and Receivers.

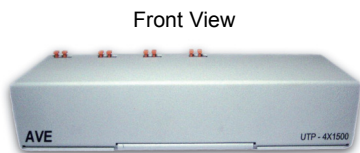

Front View

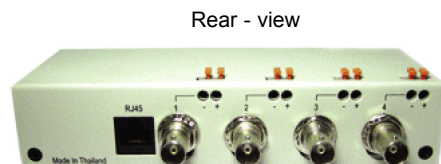

Rear - view

8 Channel Passive Hub - AVE-UTP-8x1500

AVE-UTP-8X1500 With push cage clamps & structured Wiring RJ45 for use with Passive UTP Transmitters and Receivers.

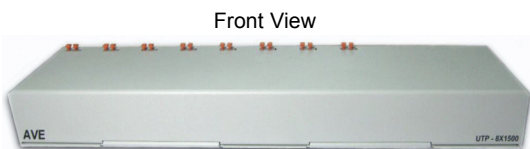

Front View

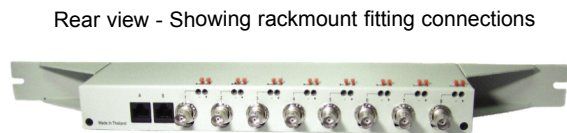

Rear view - Showing rackmount fitting connections

Showing 2 x RJ45 jack - 4 Camera's per jack.

16 Channel Passive Hub - AVE-UTP-16x1500

AVE-UTP-16X1500 With push cage clamps & structured Wiring RJ45 for use with Passive UTP Transmitters and Receivers.

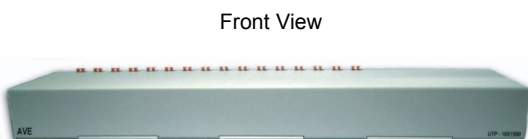

Front View

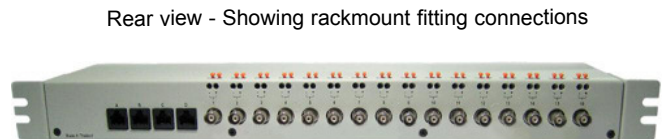

Rear view - Showing rackmount fitting connections

Showing 3 x RJ45 jack - 4 Camera's per jack.

Mounting Options

WALL MOUNT. AVE-UTP-X1500 PASSIVE HUBS use a special two piece housing that is specially designed to allow the unit to be wall mounted.



The unit can be unscrewed and easily breaks apart to access holes for secure wall mount



Once fixed to the wall the unique design enables the unit to slide onto the secured back plate and can be screwed into position.

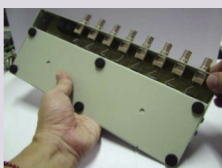

The unit can be mounted in any orientation that suits the application.



RACK MOUNT. AVE-UTP-X1500 PASSIVE HUBS Rack Mount adapters allow the units to be mounted in two ways.

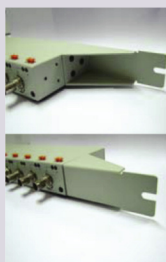

FRONT RACK MOUNT: allows rear facing connections



REAR RACK MOUNT: allows Front facing connections

RJ45 Pin Out

RJ45 JACK. The AVE Hubs include individual cage clamps for individual UTP video runs or a common RJ45 for CAT5 which can accommodate 4 video cameras in one cable run.

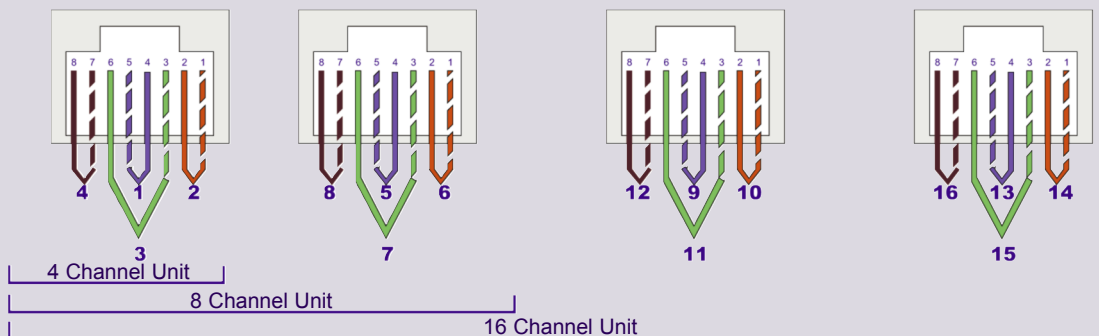

AVE (UK)
Endeavour House,
Coopers End Road,
Stansted,
Essex, CM24 1SJ

Tel: +44 (0)845 600 9323
Fax: +44 (0)845 600 9363
Email: avesales@ave-uk.com
Web: www.ave-uk.com

AVE (Europe)
123 Millennium Business Park
Ballycoolin
Dublin 11
Rep. Of Ireland

Tel: +353 (1) 8647450
Fax: +353 (1)8647451
Email: avesales@ave-europe.eu
Web: www.ave-europe.eu

AVE (USA)
2501 Central Parkway, Suite C1
Houston,
Texas TX 77092

Tel: 281-443-2300
Fax: 281-443-8915
Email: sales@aveusa.com
Web: www.aveusa.com